

# One-Click™ Cleaner D-LC Instruction Manual

Thank you for choosing the **One-Click Cleaner D-LC**. The **One-Click Cleaner D-LC** is a high-performance device designed for cleaning the ferrule end faces of Duplex LC connectors. Please carefully read this instruction manual before using this device. Please keep this instruction manual for future reference.

## 1. Safety precautions

	Though our device is deemed safe, improper usage or handling can still inflict injury to others.
	One-Click Cleaner D-LC is designed to clean Duplex LC connectors only. Fujikura is not liable for damage caused in attempt to apply this device to other applications.

## 2. Notes on usage

- Do not attempt to disassemble as this can cause damage to the device and void warranty.
- Do not re-use cleaning cloth as this will eliminate its cleaning ability.
- Do not touch the cleaning cloth as this will cause contamination.
- Do not pull the cleaning cloth, use only the device body.
- Do not use this cleaner when the cloth is empty, as this can cause damage to the connector.
- Please keep it away from items that are sensitive to magnetism.

## 3. Notes on storage for extended periods





- Do not expose device to direct sunlight, high temperature or high humidity.
- The cover on the guide cap should be closed at all times when device is not in use.

## 4. Sales enquiries

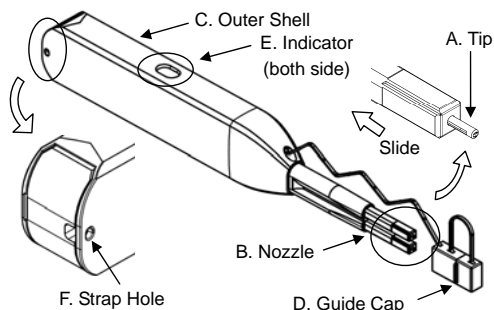
Fiber Optics Components & System Div. Fujikura Ltd  
 1-5-1 Kiba, Koto-ku, Tokyo 135-8512, JAPAN  
 TEL: +81-3-5606-1205 FAX: +81-3-5606-1535 E-mail: telcon@fujikura.co.jp

## 5. Device construction

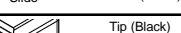

	View of Indicator	View of the Nozzle end
Full	 Cloth (White)	 Tip (Black) Cloth (White)
Little	 Cloth (White) Red	 Cloth (White)
Empty	 Red	 Tip (Black) No Cloth (Black)

Identification of remaining cloth

No.	Part Name	Function
A	Tip	Lead the cleaning cloth to the optical connector end face.
B	Nozzle	Lead tip to the optical connector end face.
C	Outer Shell	Push the outer shell to clean the connector.
D	Guide Cap	Acts as dust cap or cleaning adaptor for connector plug.
E	Indicator(both side)	Provides indication of remaining cleaning cloth.
F	Strap Hole	Can pass the strings through the strap hole.

## 6. Applications

### <Connector inside adaptor>

1. Remove Guide Cap from the device.

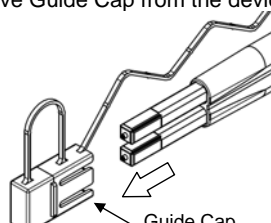

2. Insert tip of cleaner into Duplex LC Adaptor.

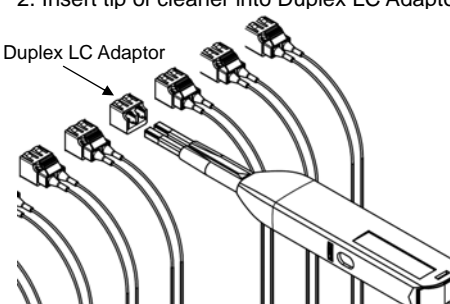

3. Push the Outer Shell to start cleaning the Duplex LC connector end face. An audible "click" sound indicates end of cleaning process. Close the cover after use.

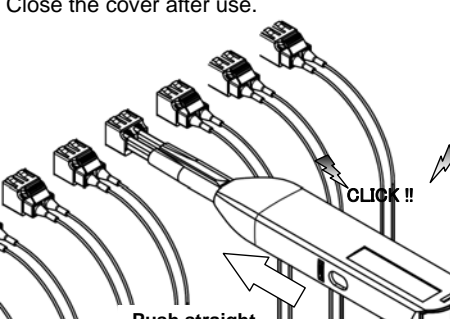

Be careful not to slant the One-Click Cleaner D-LC while inserting into the adaptor.

Do not overly exert force during insertion as this may cause damage to both the connector and the One-Click Cleaner D-LC.

If pushing Outer Shell is inhibited, remove One-Click Cleaner D-LC and verify there is no sizeable debris is inhibiting the cleaning process.

### <Connector plugs alone>

1. Open the Cover on the Guide Cap.

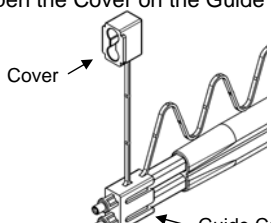

2. Insert Duplex LC connector into the Guide Cap.

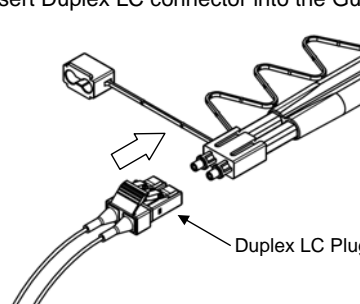

3. Push the Outer Shell to initiate the cleaning the Duplex LC connector end face. An audible "click" sound indicates end of cleaning process. Close the cover after use.

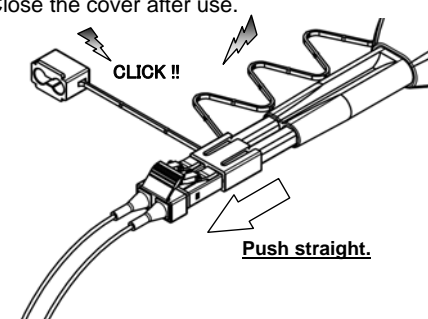

Be careful not to slant connector while inserting into the Guide cap.

Do not overly exert force during insertion as this may cause damage to both the connector and the One-Click Cleaner D-LC.

If pushing Outer Shell is inhibited, remove One-Click Cleaner D-LC and verify there is no sizeable debris is inhibiting the cleaning process.