

# One-Click™ Cleaner MPO-16 Instruction Manual

Thank you for choosing the One-Click™ Cleaner MPO-16. This product is a high-performance device designed for cleaning the ferrule end faces of all TIA-604-18 compliant MPO connectors. Please carefully read this instruction manual before using this device. Please keep this instruction manual for future reference.

## 1. Safety precautions

	Though our device is deemed safe, improper usage could cause injury.
	One-Click™ Cleaner MPO-16 is designed to clean all TIA-604-18 compliant MPO connectors only. Fujikura is not liable for damage caused in attempt to apply this device to other applications. It does not support MPO connectors(IEC61754-7-1) have guide pins as the distance between two pin-hole centres is 4.6mm.

## 2. Notes on usage

- Do not attempt to disassemble as this can cause damage to the device and void warranty.
- Do not re-use cleaning cloth as this will eliminate its cleaning ability.
- Do not touch the cleaning cloth as this will cause contamination.
- Do not pull the cleaning cloth, use only the device body.
- Do not use this cleaner when the cloth is empty, as this can cause damage to the connector.
- Please keep it away from items that are sensitive to magnetism.

## 3. Notes on storage for extended periods

- Do not expose device to direct sunlight, high temperature or high humidity.
- The cover on the guide cap should be closed at all times when device is not in use.





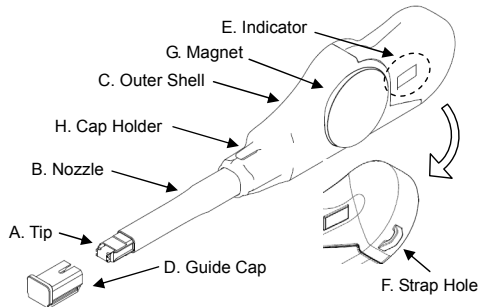

## 4. Sales inquiries

Please refer to website:  
<http://www.oneclickcleaner.com/>

## 5. Device construction



Identification of remaining

	View of Indicator	View of Nozzle end
Full	 Cloth(White)	 Tip (Violet) Cloth (White)
Little	 Cloth(White)	
Empty	 Clear	 Tip is recessed no longer engages and is unmoving

No.	Part Name	Function
A	Tip	Aligns the cleaning cloth to the connector end face when cleaning through the connector adapter.
B	Nozzle	Allows the tip to reach connector adapters in patch panels.
C	Outer Shell	Houses cleaning cloth and pushed forward to clean the connector.
D	Guide Cap	Acts as a dust cap and is used as an adapter to cleaning connectors on plugs.
E	Indicator	Provides indication of remaining cleaning cloth.
F	Strap Hole	Can be used to attach a strap to the cleaner (strap not included).
G	Magnet	Used to stick to metal patch panel or work area when not in use.
H	Cap Holder	Used to store the guide cap when not in use.

## 6. Applications

### <Connector inside adapter>

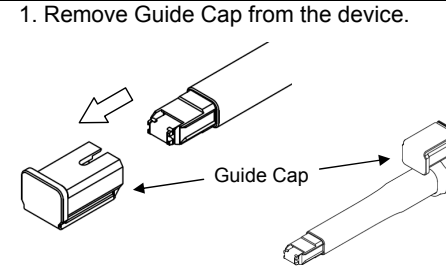

1. Remove Guide Cap from the device.

2. Insert tip of cleaner into 16MPO Adapter.

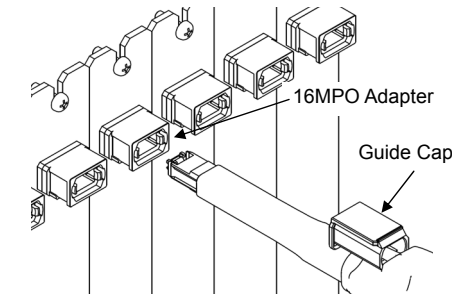

※Please apply to 16-fiber MPO connectors only

3. Push the Outer Shell to start cleaning the connector end face. An audible “click” sound indicates end of cleaning process. Close the cover after use.

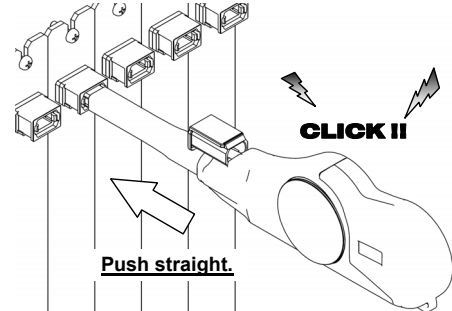

Be careful not to slant the One-Click™ Cleaner MPO-16 while inserting into the adapter. Do not overly exert force during insertion as this may cause damage to both the connector and this product.

※If pushing Outer Shell is inhibited, remove this product from the connector and verify that there is no large debris inhibiting the cleaning process.

### <Connector on jumper>

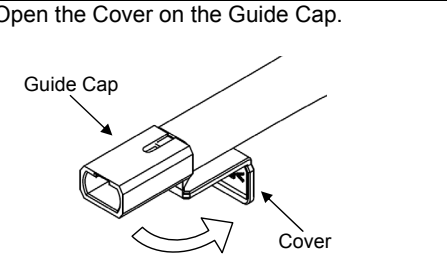

1. Open the Cover on the Guide Cap.

2. Insert 16MPO connector into the Guide Cap.

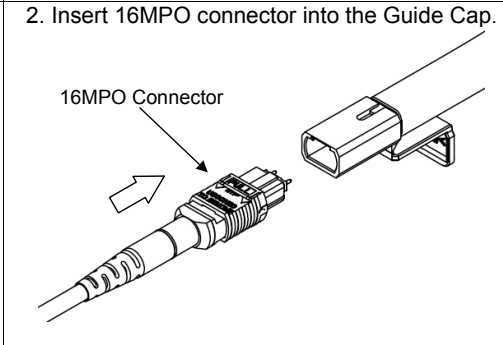

※Please apply to 16-fiber MPO connectors only

3. Push the Outer Shell to initiate the cleaning the connector end face. An audible “click” sound indicates end of cleaning process. Close the cover after use.

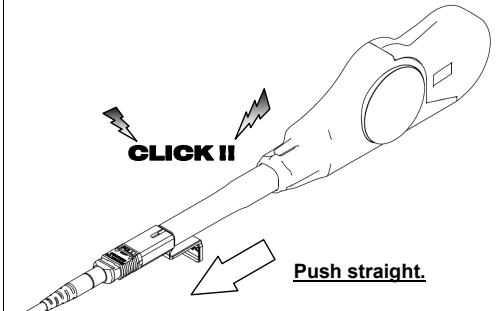

Be careful not to slant connector while inserting into the Guide cap. Do not overly exert force during insertion as this may cause damage to both the connector and this product.

※ If pushing Outer Shell is inhibited, remove this product from the connector and verify that there is no large debris inhibiting the cleaning process.